

marantz®

**Model 4430
Quadradial 4
Receiver**

MARANTZ CO., INC. P.O. BOX 99 · SUN VALLEY, CALIFORNIA · 91352
A WHOLLY-OWNED SUBSIDIARY OF SUPERSCOPE INC., SUN VALLEY, CALIFORNIA 91352

WARRANTY

All parts of MARANTZ products are fully guaranteed for a period of THREE YEARS from date of purchase, except for tubes which are guaranteed for NINETY DAYS from date of purchase, and except for speaker products. Speaker products are guaranteed as follows: all speaker and electronic components are fully guaranteed for a period of THREE YEARS from date of purchase; the cabinetry is guaranteed against manufacturing defects only, for a period of TWO YEARS from date of purchase.

In the event that service is required, all necessary parts and labor will be furnished free of charge during the above stated periods. The conditions of this Warranty, and the extent of the responsibility of MARANTZ COMPANY, INC. under this Warranty, are as follows:

1. The purchase must have been made from an authorized MARANTZ dealer.

2. The Warranty extends only in favor of the original, registered owner of the product.

3. The Warranty Registration Card must be transmitted to MARANTZ COMPANY, INC., P.O. Box 99, Sun Valley, California 91352, not later than TEN DAYS from date of purchase.

4. The Warranty will become void of repairs are effected by anyone other than an authorized MARANTZ Service Station.

5. If it becomes necessary to send this product or any defective part to MARANTZ COMPANY, INC., or to an authorized MARANTZ Service Station, all shipping charges must be fully prepaid. If the entire instrument is sent, it must be shipped in its original package. No accessories should be shipped with the product. If any accessories are shipped with the product, MARANTZ COMPANY, INC. shall have no liability whatsoever for loss of or damage to any such accessories, nor for the safe return thereof.

6. This Warranty shall be valid only if the purchase was made within the United States of America. The Warranty shall not apply unless shipment is made by the purchaser to the MARANTZ Service Station from a point within the United States. If the requested repairs and/or parts exchange are within the terms of this Warranty, MARANTZ COMPANY, INC. will prepay return shipping charges, provided that such return shipment is to be made to an address located within the United States.

7. This Warranty is void if the Serial Number has been altered or removed. This Warranty shall not apply if the product has not been connected or operated in accordance with the instructions furnished by MARANTZ COMPANY, INC. This Warranty shall also be void if the product has been altered or repaired in any way which MARANTZ COMPANY, INC. believes has affected the stability or reliability of the product.

8. MARANTZ COMPANY, INC. shall have no liability whatsoever for consequential damages. The sole responsibility of MARANTZ COMPANY, INC. under this Warranty shall be limited to the repair of the product, or replacement thereof, in the sole discretion of MARANTZ COMPANY, INC.

9. This Warranty does not include the furnishings of labor or parts for user maintenance, as the same is described in the instruction manual or handbook furnished with this product.

10. This Warranty is valid only with respect to repairs effected by an authorized MARANTZ Service Station.

11. EXCEPT TO THE EXTENT THAT APPLICABLE LAW PRECLUDES A DISCLAIMER OF WARRANTY, THERE IS NO IMPLIED WARRANTY OF MERCHANTABILITY OR FITNESS WITH RESPECT TO THIS PRODUCT, NOR ARE THERE ANY OTHER WARRANTIES WHICH EXTEND BEYOND THE PROVISIONS OF THIS WARRANTY. ORDINARY PERIODIC CHECK-UPS ARE NOT INCLUDED IN THIS WARRANTY.

12. MARANTZ COMPANY, INC. reserves the right to make changes in design and/or improvements upon its products without any obligation to include these changes in any products theretofore manufactured.

TO PROTECT YOUR RIGHTS UNDER THIS WARRANTY, FILL OUT AND MAIL THE WARRANTY REGISTRATION CARD TO MARANTZ COMPANY, INC., P.O. BOX 99, SUN VALLEY, CALIFORNIA 91352, NOT LATER THAN TEN DAYS FOLLOWING THE DATE OF PURCHASE.

Should there be any questions, please contact the
Marantz National Service Manager, Marantz Company, Inc.,
P.O. Box 99, Sun Valley, California 91352

PURCHASER'S RECORD ►

REGISTRATION FOR MARANTZ 3-YEAR GOLDEN WARRANTY

Model: Marantz Model 4430 _____

Serial No. _____

Purchaser's Name _____

Purchased From (Name) _____

Address _____

Price Paid \$ _____ Date Purchased _____

Date Warranty Reply Card Mailed _____

The above information becomes your permanent record of a valuable purchase. It should be promptly filled in at the same time that you fill in and mail the warranty registration reply card to Marantz. This information provides a valuable insurance record and must also be referred to should you have any correspondence with Marantz.

TABLE OF CONTENTS

| | |
|---|----|
| Connecting the Model 4430 | 2 |
| Source Devices | 3 |
| 2-Channel | 3 |
| 4-Channel | 3 |
| Remote Speakers | 3 |
| Speaker Phasing | 3 |
| Speaker Placement | 4 |
| Front Panel Features | 4 |
| Mode Switch | 4 |
| Mono | 4 |
| 2-Channel | 6 |
| Discrete | 6 |
| Vari-Matrix | 6 |
| SQ Decoder | 6 |
| Dimension | 6 |
| Balance Controls | 6 |
| Selector Switch | 6 |
| Bass and Treble Controls | 6 |
| Tape/Source Monitor Switch | 6 |
| Remote Control Switch | 8 |
| Main and Remote SPKR Switches | 8 |
| Power Switch | 8 |
| Front and Rear Phones Jacks | 8 |
| Loudness Switch | 8 |
| HI Filter Switch | 8 |
| Tuning Meter | 8 |
| Tuning | 8 |
| Muting Switch and Muting Level Control | 8 |
| FM Mono Switch | 8 |
| Volume | 8 |
| Rear Panel Features | 9 |
| Phones Jacks | 9 |
| <u>AUX₁, AUX₂ Jacks</u> | 9 |
| <u>Tape In and Tape Out Jacks</u> | 9 |
| FM antenna Terminals | 9 |
| Antenna Attenuator | 10 |
| AM Antenna Terminal | 10 |
| FM Quadradial Output Jack | 10 |
| Main and Remote Speakers | 11 |
| Connection to AC Outlet | 11 |
| AC Convenience Outlets | 11 |
| Remote Control | 11 |
| External Decoder Connection | 11 |
| Tape Recording | 11 |
| Technical Description | 12 |
| General | 12 |
| Functional Description | 12 |
| Front End | 12 |
| IF Stages | 13 |

| | |
|------------------------------|----|
| Limiter | 13 |
| FM Stereo Demodulator | 13 |
| Muting Circuit | 13 |
| AM Tuner | 13 |
| Phono Amplifiers | 13 |
| Selector Switch | 14 |
| Monitor (Tape/Source) Switch | 14 |
| Monitor (1 or 2) Switch | 14 |
| Tone Control | 14 |
| Power Amplifier | 14 |
| Technical Specifications | 15 |
| Typical Performance Curve | 16 |
| Service Note | 19 |

LIST OF ILLUSTRATIONS

| | |
|--|------|
| 1. Front Panel Controls and Jacks | 2 |
| 2. Connection Diagram (A, B) | 2, 4 |
| 3. Speaker Placement | 5 |
| 4. Mono Mode Sound Dispersion | 7 |
| 5. 2-channel Mode Sound Dispersion | 7 |
| 6. Discrete Mode Sound Dispersion | 7 |
| 7. Vari-Matrix Mode Sound Dispersion | 7 |
| 8. Rear Panel Connection Facilities | 9 |
| 9. FM/AM Antenna Connection | 9 |
| 10. AM Ferrite-rod Antenna | 10 |
| 11. Quick-Connect Speaker Terminal | 10 |
| 12. Functional Block Diagram | 12 |
| 13. FM Characteristics | 16 |
| 14. Stereo Separation | 16 |
| 15. Phono Equalization Characteristics | 17 |
| 16. Tone Control Characteristics | 17 |
| 17. Harmonic Distortion | 18 |
| 18. Frequency Response | 18 |
| 19. Packing Instructions | 19 |

GENERAL DESCRIPTION

Your Marantz Model 4430 is a high-quality Quadradiol 4 Receiver developed by Marantz, a name famous for quality in the audio component industry. The Model 4430 incorporates Marantz exclusive Vari-Matrix circuit which simulates 4-channel sound from normal 2-channel stereo programs, and is capable of reproducing 4-channel sound from any matrix-encoded source. The 4430 will also reproduce any discrete 4-channel program as well as regular stereo and monaural programs. An optional plug-in decoder adapts the 4430 for any specific matrix system such as Columbia's SQ or Electro-Voice's Stereo 4.

The FM tuner section employs a FET for the RF amp. and MIX stage. The IF tuning circuit employs ceramic filters of wider bandwidth and higher selectivity to provide high sensitivity and unparalleled interference free capacity.

The FM Multiplex Circuitry includes a stereo-monoaural Automatic switching circuit, stereo indicator circuit and a buffer amplifier to obtain output power at low impedance. An SCA filter is incorporated as well as low path filters for the 19KHz and 38KHz bands. Moreover the Model 4430 unit has a perfect muting circuit that permits pleasant eliminating FM Broadcast reception by completely inter-station interference which is usually generated at the time of selecting FM stations.

FOREWORD

To obtain optimum performance and enjoyment from the Model 4430, please study these instructions carefully. Installation and operation are not complicated if step-by-step instructions are followed.

This manual is divided into two parts. The first covers installation and operation in simple, non-technical language. The second describes the Model 4430 in more detail with technical specifications and functional explanations.

For quick identification of the controls and connections, references to them are printed in bold face type, exactly as they appear on the front and rear panels of the Model 4430.

AFTER UNPACKING

It is advisable to save all original packing material to prevent damage should you wish to transport or ship the receiver (refer to Fig. 19 for packing instructions). Please inspect your Model 4430 carefully for any signs of damage in transit. It has undergone stringent quality control inspection and tests prior to packing, and left the factory in perfect operating condition. If the unit is damaged, notify the carrier without delay. Only the consignee may institute a claim with the carrier for damage during shipment. However, the Marantz Company will cooperate fully in such an event. Save the damaged carton as evidence for inspection by the carrier.



Figure 1. Front Panel Controls and Jacks

CONNECTING THE 4430

- Using a balanced and shielded 300-ohm cable, connect an FM antenna to the 4430 as shown in Figure 9.
- Using No. 18 or heavier lamp cord (zip cord), connect main speakers to the 4430 as follows:

LEFT FRONT SPEAKER **4430**
 - or GND or NEG or to **MAIN SPEAKERS**
 COMM or 0 **FRONT L -**
 + or HOT or POS or 1 to **MAIN SPEAKERS**
 FRONT L +

RIGHT FRONT SPEAKER **4430**
 - or GND or NEG or to **MAIN SPEAKERS**
 COMM or 0 **FRONT R -**
 + or HOT or POS or 1 to **MAIN SPEAKERS**
 FRONT R +

LEFT REAR SPEAKER **4430**
 - or GND or NEG or to **MAIN SPEAKERS**
 COMM or 0 **REAR L -**
 + or HOT or POS or 1 to **MAIN SPEAKERS**
 REAR L +

RIGHT REAR SPEAKER **4430**
 - or GND or NEG or to **MAIN SPEAKERS**
 COMM or 0 **REAR R -**
 + or HOT or POS or 1 to **MAIN SPEAKERS**
 REAR R +

- Using shielded audio cables with phono plugs, connect your record player to the 4430 as follows:

RECORD PLAYER **4430**
 LEFT OUTPUT to **PHONO L**
 RIGHT OUTPUT to **PHONO R**

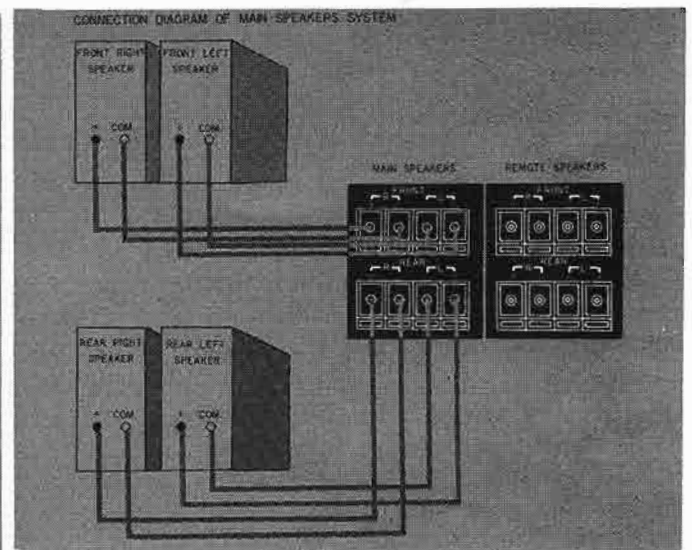

Figure 2. A Connection Diagram

- If any discrete 4-channel playback device (Q-8 cartridge player, 4-channel reel-to-reel player, RCA/JVC discrete disc demodulator, etc.) is to be engaged in the system, make connections between the device and the 4430 using shielded audio cables with phono plugs:

DISCRETE 4-CHANNEL PLAYBACK DEVICE **4430**
 LEFT-FRONT or LF or to **FRONT TAPE/**
 CHANNEL 1 or TRACK 1 **AUX L**
 LEFT-REAR or LR or to **REAR TAPE/**
 CHANNEL 2 or TRACK 2 **AUX L**
 RIGHT-FRONT or RF or to **FRONT TAPE/**
 CHANNEL 3 or TRACK 3 **AUX R**
 RIGHT-REAR or RR or to **REAR TAPE/**
 CHANNEL 4 or TRACK 4 **AUX R**

5. Using shielded audio cables with phono plugs, connect a discrete 4-channel tape recorder to the 4430 as follows:

DISCRETE 4-CHANNEL TAPE RECORDER 4430

| | |
|-----------------------------------|---------------------|
| LEFT-FRONT OUTPUT or LINE OUT | to FRONT TAPE IN L |
| LEFT-REAR OUTPUT or LINE OUT | to REAR TAPE IN L |
| RIGHT-FRONT OUTPUT or LINE OUT | to FRONT TAPE IN R |
| RIGHT-REAR OUTPUT or LINE OUT | to REAR TAPE IN R |
| LEFT-FRONT INPUT or LINE IN | to FRONT TAPE OUT L |
| LEFT-REAR INPUT or LINE IN | to REAR TAPE OUT L |
| RIGHT-FRONT INPUT or LINE IN | to FRONT TAPE OUT R |
| RIGHT-REAR INPUT or LINE IN | to REAR TAPE OUT R |

6. Pull the AM ferrite-rod antenna out as shown in Figure 10.

7. Set the controls and switches as follows:

| | |
|------------------------------------|---|
| FRONT L-R balance | Mid position |
| REAR L-R balance | Mid position |
| FRONT-REAR balance mode | Mid position VARI-MATRIX |
| dimension | Mid position |
| remote control | LOCAL |
| bass and treble controls volume | Mid position Minimum (fully counter-clockwise) |
| MAIN SPKR | ON (in) |
| REMOTE SPKR | OFF (out) |
| FM MONO | OFF (out) |
| MUTING | ON (in) |
| MONITOR | SOURCE (out) |
| HI FILTER | OFF (out) |
| LOUDNESS | OFF (out) |
| power | OFF (out) |

8. Plug the 4430 into the A.C. wall outlet.
9. Turn the power switch ON.
10. Select the desired program source by setting the selector switch to appropriate position.
11. If phono is selected, put on a stereo record. If FM is selected, tune to a stereo broadcast.
12. Increase the volume control to a comfortable listening level.

Your complete 4-channel system is now operative, and you may experiment with the various controls to discover their effects.

The remainder of this manual explains how to use your system most effectively.

SOURCE DEVICES

2-CHANNEL

A stereo record player may be connected to the PHONO jacks.

High level 2-channel playback devices (tuner, tape player, record player with equalized high level output, etc.) may be connected to the FRONT INPUTS AUX₁, AUX₂, TAPE₁, TAPE₂ or TAPE IN jacks.

4-CHANNEL

Discrete 4-channel playback devices (Q-8 cartridge player, 4-channel reel-to-reel player, RCA/JVC discrete disc demodulator, etc.) may be connected to the AUX₁, AUX₂, TAPE₁ or TAPE₂ jacks of the 4430.

REMOTE SPEAKERS

The 4430 can accommodate both main and remote speaker systems. A second group of four speakers may be set up in another room. Connect these four remote speakers to the REMOTE SPEAKERS terminals as you did the main speakers.

The MAIN and REMOTE SPKR switches on the front panel now permits activation of MAIN and/or REMOTE groups of loud speakers.

NOTE: Do not use 4-ohm speakers if main and remote speakers are to be used simultaneously. Use 8 or 16-ohm speakers only.

SPEAKER PHASING

To assure the best 4-channel separation and frequency response, the following tests will verify that all four speakers are correctly phased.

1. After the speakers are connected to the 4430 place all four speakers in the center of the room.
2. Set Mode switch at MONO. Play a record (or radio or tape) with strong bass tones, at a low volume level. Center the FRONT L-R and REAR L-R balance controls. Set FRONT-REAR balance control at extreme FRONT position.
3. Position the front (left and right) speakers about six inches apart, face-to-face. Listen, particularly to the apparent loudness of the bass tones.
4. Next, turn off all power, but do not disturb the volume, tone, or balance settings. Reverse connections on the right-front speaker only. Turn on the power, and listen again. If the bass tones now seem louder than in (3), you have corrected the phasing between the front (left and right) speakers. If the bass tones now sound softer, then turn off all power, and reconnect the right-front speaker as you first had it connected.

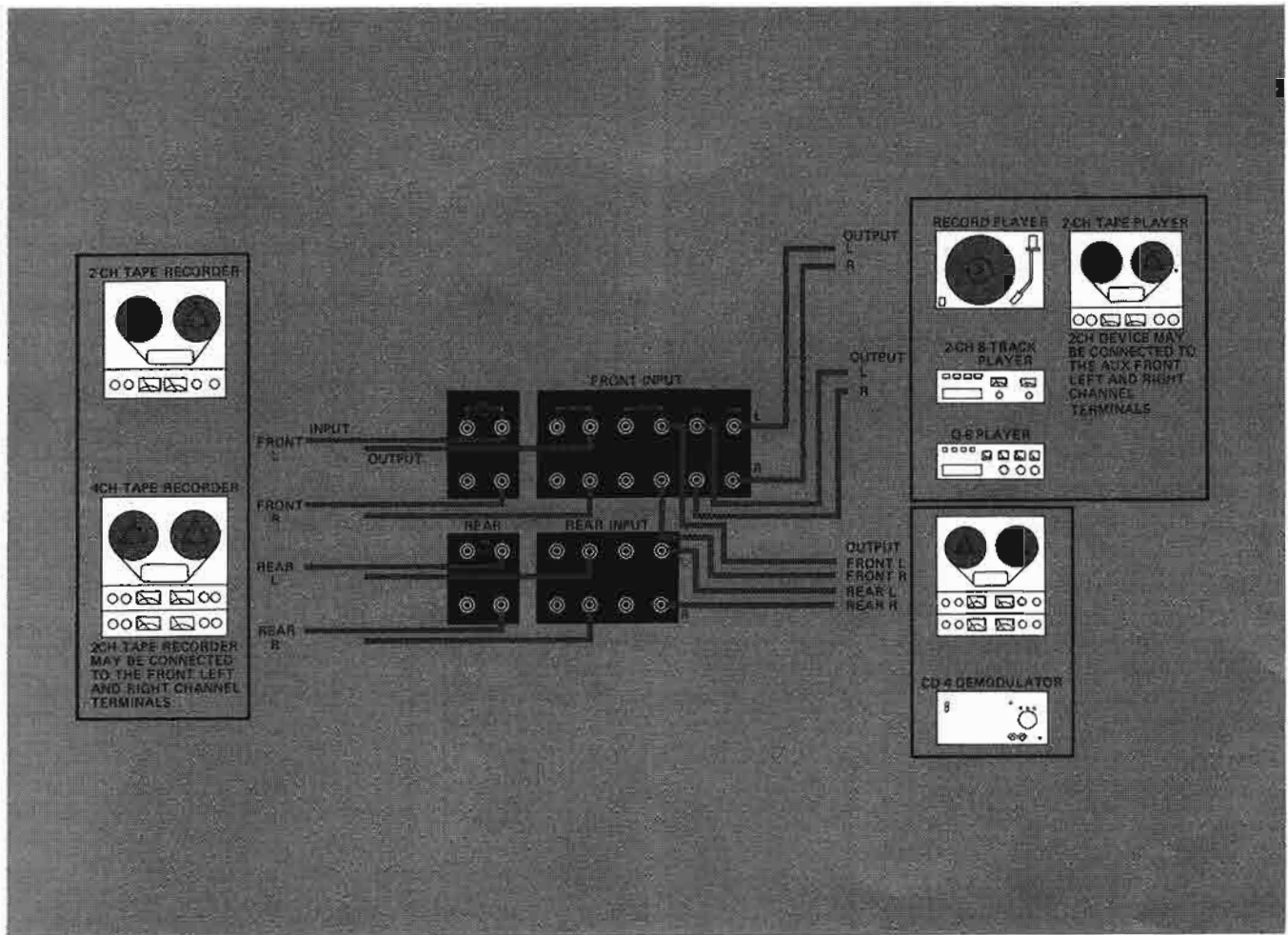

Figure 2.B Connection Diagram

5. Now check phasing between the two left (front and rear) speakers. Set both **FRONT L-R** and **REAR L-R balance** controls at extreme **L** position, and set **FRONT-REAR balance** for equal loudness from the two speakers. Position the two speakers face-to-face, about six inches apart, and listen for bass as in (3).
6. Turn off power. Experimentally reverse connections **only** on the left rear speaker. Turn on power and listen. Retain the left-rear speaker connections which give the "best bass" as in (4).
7. Last, check phasing between the two rear (left and right) speakers. Center both **FRONT** and **REAR balance** controls. Set **FRONT-REAR balance** control at extreme **REAR** position. Position the two rear speakers face-to-face as before. Listen for bass.
8. Turn off power. Experimentally reverse connections **only** on the right rear speaker. Listen again to determine the "best bass" method of connecting the right-rear speaker. All speakers will then be in phase, and you may use all controls normally.
9. Once having phased your four speakers, you need not repeat the procedure in the future if you now codify the speaker connections and/or the speaker cables. Any method of codifying is satisfactory, provided it enables you in the future to duplicate your now-correct hookup between speakers and amplifiers.

SPEAKER PLACEMENT

Experimentation will reveal the best speaker locations in your room. The following placements are suggested.

FRONT PANEL FEATURES

MODE SWITCH MONO

When the mode switch is in the **MONO** position, all input signals are summed. Speakers are driven as shown in Figure 4.

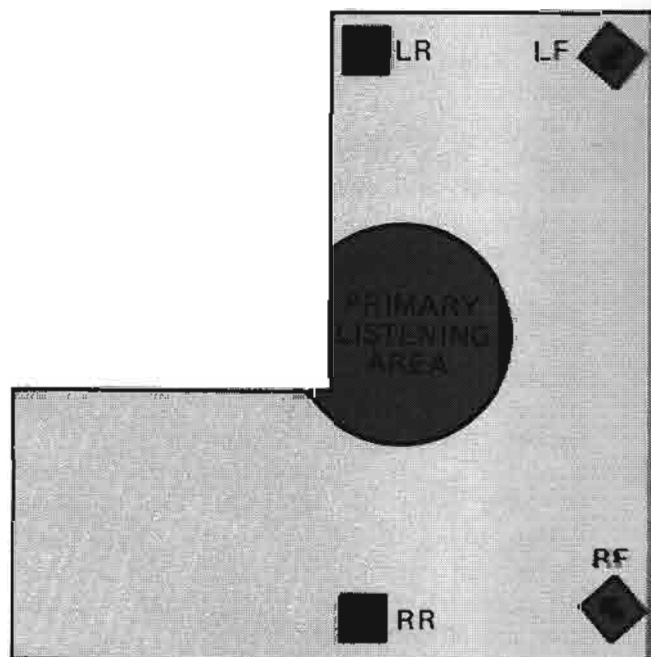
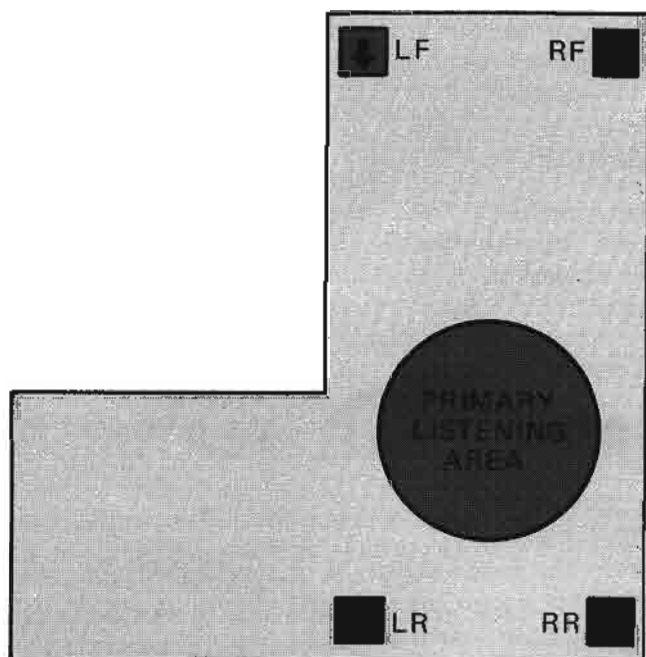
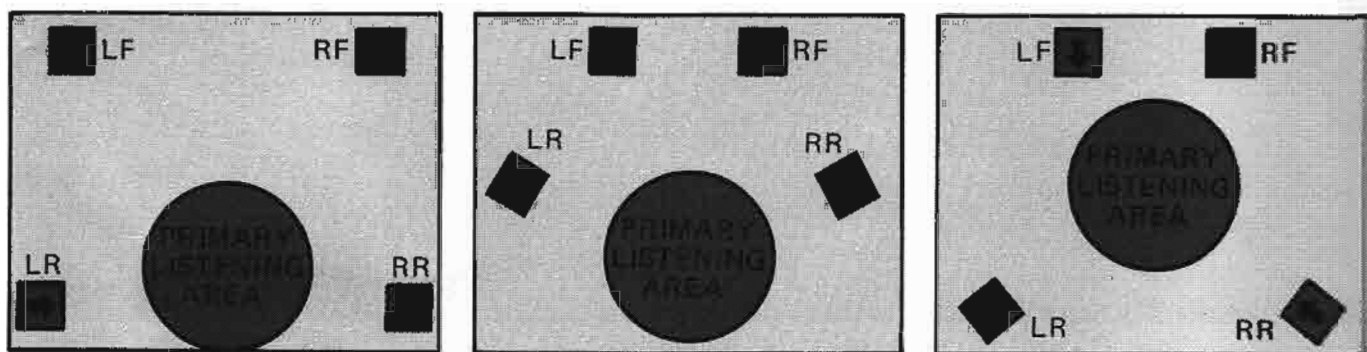
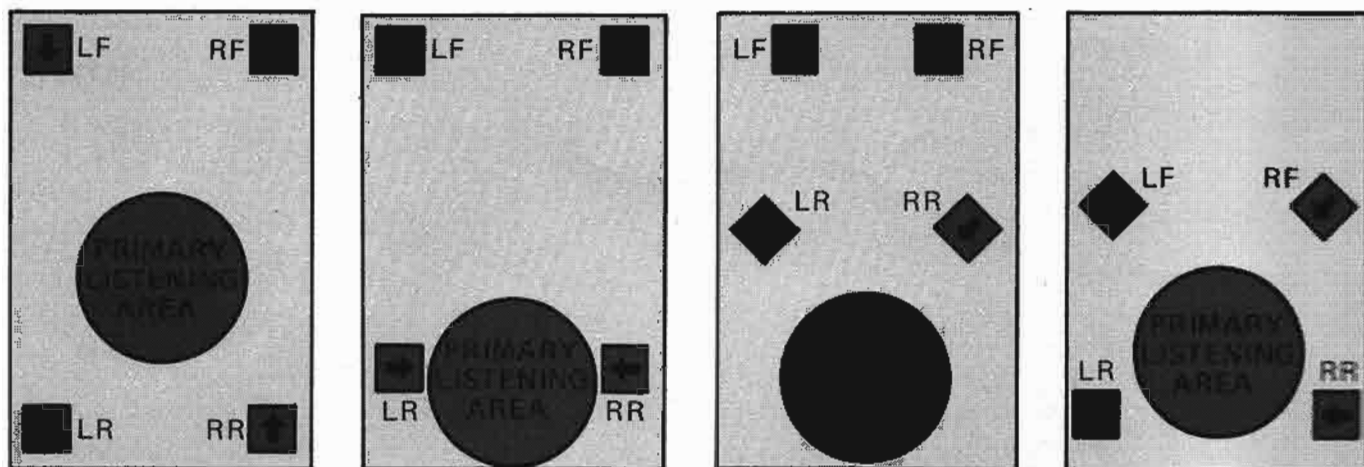

Figure 3. Speaker Placement

Use the **MONO** position for a) Phasing speakers and b) Playing a monaural source such as TV audio, AM radio, or monaural records through all four channels.

2 CH

When the mode switch is in the **2 CH** position, left-front and left-rear inputs are summed. Right-front and right-rear inputs are summed. Speakers are driven as shown in **Figure 5**.

Use the **2 CH** position for playing regular stereo records without synthesizing rear channels.

DISCRETE

When the mode switch is in the **DISCRETE** position, each input signal goes to its respective output channel. Speakers are driven as shown in **Figure 6**.

Use the **DISCRETE** position for: a) Playing discrete 4-channel sources such as Q-8 cartridges, or RCA/JVC records, and b) Playing 2-channel stereo programs through front speakers only.

VARI-MATRIX

When the mode switch is in the **VARI-MATRIX** position, rear input signals are internally disconnected. Left-front and right-front inputs feed left-front and right-front speakers, as in the **DISCRETE MODE**. Rear channel signals are "synthesized" or derived from the left-front and right-front input signals. The characteristics of the rear channel signals are varied by the **dimension** control. Speakers are driven as shown in **Figure 7**.

SQ DECODER

With the mode switch on **SQ DECODER**, any rear input signals to the 4430 are internally disconnected. The rear channel outputs are, instead, derived from front channel signals which have been processed by the plug-in decoder. The characteristics of these derived rear channel outputs are determined by the type of plug-in decoder.

Use the **SQ DECODER** position only with an optional plug-in decoder installed. Without this optional decoder, there will be no output when the mode switch is on **SQ DECODER**.

DIMENSION

The **dimension** control is operative only when the mode switch is set to the **VARI-MATRIX** position. This control optimizes the 4-channel **VARI-MATRIX** effect.

BALANCE CONTROLS

The Model 4430 has three balance controls: **FRONT L-R**, **REAR L-R**, and **FRONT-REAR**. The **FRONT L-R** slide knob adjusts the balance between the front left and right channels. The **REAR L-R** slide knob adjusts the balance between the rear left and right channels. The **FRONT-REAR** slide knob adjusts the balance between front and rear pairs of channels. To balance the front channels, first set the **FRONT-REAR** control all the way to the **FRONT**, to silence the rear speakers while you adjust the **FRONT L-R balance** control. To balance the rear channels, move the **FRONT-REAR** control all the way to **REAR**, and then adjust **REAR L-R balance**. Now you are ready to adjust the **FRONT-REAR** control for the most pleasing overall balance.

SELECTOR SWITCH

The selector switch selects the program source for listening or recording. The switch can select any of six signal sources: **AM**, **FM**, **PHONO**, **TAPE**, **AUX₁** and **AUX₂**. With the switch set at **TAPE**, the signal source connected to the **TAPE** jacks on the rear panel can be played back.

BASS AND TREBLE CONTROLS

These controls are used to adjust the tonal balance of program material to suit your individual listening preference. The bass and treble responses are adjusted by dual concentric friction-coupled type variable resistors provided for both front and rear pairs of channels. With both **bass** and **treble** controls set at the center position, frequency response of the amplifier becomes flat. The smaller knob adjusts the response of the front audio channel, while the larger knob adjusts the rear audio channel.

Turn either tone control knob clockwise to boost, or counter-clockwise to attenuate its respective frequency range.

TAPE/SOURCE SWITCH.

When this pushswitch is out (**SOURCE**) the program being recorded and heard is determined by the setting of the selector switch. With the **MONITOR** pushswitch in (**TAPE**), the amplifier input connections are switched to the output of the tape recorder without affecting the signal presented to the tape recorder without affecting the signal presented to the tape recorder's input. Thus you may listen to the source signal before and after it is recorded (on a 3-head tape recorder).

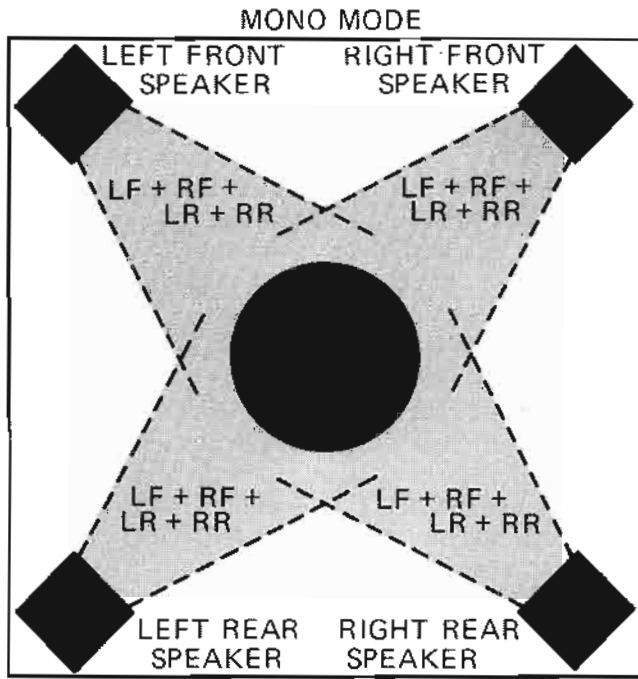

Figure 4. Mono Mode Sound Dispersion

INPUT SIGNAL DESIGNATIONS
 LF=LEFT FRONT RF=RIGHT FRONT
 LR=LEFT REAR RR=RIGHT REAR

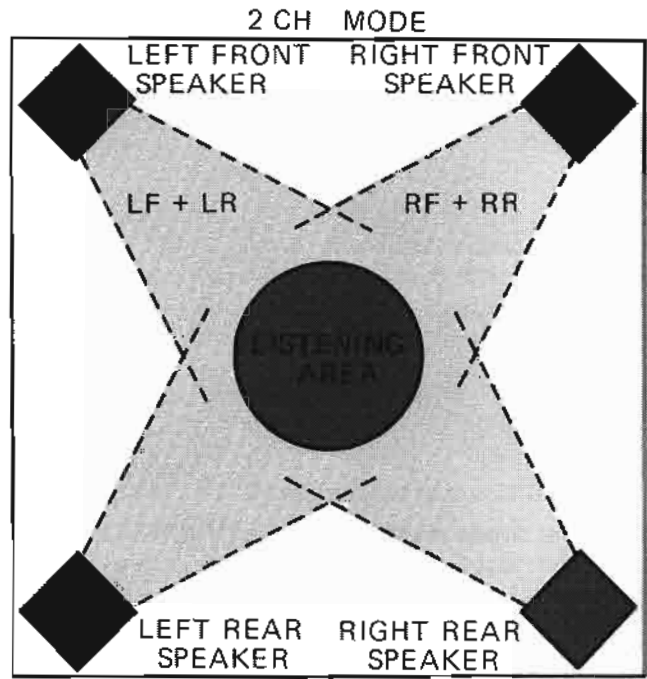

Figure 5. 2-channel Mode Sound Dispersion

INPUT SIGNAL DESIGNATIONS
 LF=LEFT FRONT RF=RIGHT FRONT
 LR=LEFT REAR RR=RIGHT REAR

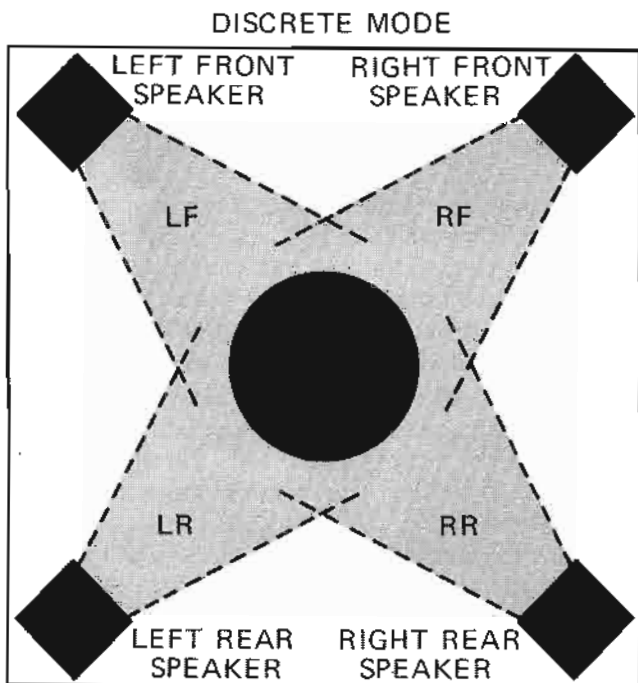

Figure 6. Discrete Mode Sound Dispersion

INPUT SIGNAL DESIGNATIONS
 LF=LEFT FRONT RF=RIGHT FRONT
 LR=LEFT REAR RR=RIGHT REAR

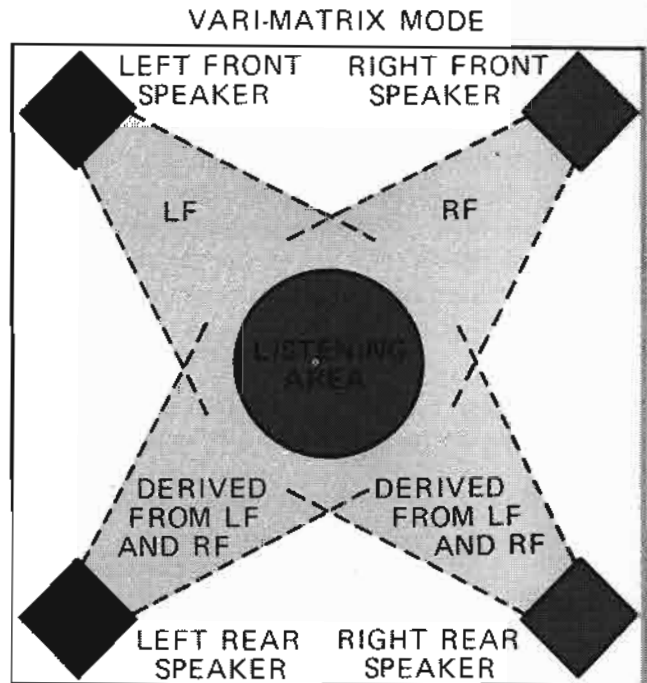

Figure 7. Vari-Matrix Mode Sound Dispersion

INPUT SIGNAL DESIGNATIONS
 LF=LEFT FRONT RF=RIGHT FRONT
 LR=LEFT REAR RR=RIGHT REAR

A tape recorder to be monitored is selected by this pushswitch. When this pushswitch is "out (2)," the tape recorder connected to the TAPE 2 jacks on the rear panel is monitored. With the pushswitch "in (1)," the tape recorder connected to the TAPE 1 jacks is selected.

To monitor a recording on a three-head tape re-

recorder while a program is being recorded, be sure the mode switch is in the **DISCRETE**, **VARI-MATRIX**, or **SQ DECODER** position. The recorded signal may be compared to the source signal by using the **TAPE MON** switch.

To record a discrete 4-channel source on a 4-channel recorder, put the mode switch in **DISCRETE**.

To record a 2-channel stereo program on a 2-channel recorder, put the **mode** switch in the **2 CH** or **DISCRETE** position.

To record a discrete 4-channel source on a 2-channel recorder, put the **mode** switch in the **2 CH** position. Leave the **TAPE/SOURCE** button out (**SOURCE**) while recording. This will feed the sum of the left-front and left-rear inputs to the left-front **TAPE OUT** jack, and the sum of the right-front and right-rear inputs to the right-front **TAPE OUT** jack.

To record any type of source on a monaural recorder, put the **mode** switch in the **MONO** position. Leave the **TAPE/SOURCE** button out (**SOURCE**) while recording.

REMOTE CONTROL SWITCH

This switch assigns control of balance and volume to the optional RC-4 Remote Control. When the RC-4 is not used, the **remote control** switch must be in the **LOCAL** position.

MAIN AND REMOTE SPKR SWITCHES

These switches select the loudspeaker terminals to which audio power is fed. The **MAIN** and **REMOTE** groups of loudspeakers may be operated separately or simultaneously. With both speaker switches in the "out" position, all loudspeakers are disconnected. The signal at the **FRONT** and **REAR** headphones jacks is not affected by the **MAIN** and **REMOTE SPKR** switches.

POWER SWITCH

This pushswitch turns the power on and off. When the **power** switch is "in" the dial lamps illuminate. Be sure to turn the **power** pushswitch off before plugging or unplugging the power cord.

FRONT AND REAR PHONES JACKS

These jacks accept a standard 3-conductor phone plug employed with standard stereo or 4-channel headphones. When using 2-channel headphones, insert the plug into the **FRONT phones** jack. When using 4-channel headphones, insert the front plug into the **FRONT phones** jack and the rear plug into the **REAR phones** jack. Either high- or low-impedance headphones may be used.

LOUDNESS SWITCH

When listening at low levels, set this switch "in". The **LOUDNESS** switch boosts bass and treble tones to compensate for the human ear's response to those frequencies at low volume levels.

HI FILTER SWITCH

With this pushswitch set "in", the high frequency filter suppresses high frequency noise such as "scratch" from worn phonograph records, and tape "hiss". The filter will also slightly reduce high frequencies in the program material. When the program does not have high frequency noise, the **HI FILTER** pushswitch should be "out".

TUNING METER

The model 4430 is equipped with two meters, a **SIGNAL STRENGTH** Meter and a **TUNING** Meter. The **SIGNAL STRENGTH** meter indicates the signal strength of any AM or FM broadcast. The **TUNING** Meter operates on FM only and indicates correct station tuning.

TUNING

AM: For optimum AM reception, tune to the desired station. Then rotate the **TUNING** knob slightly back and forth until the maximum reading is obtained on the **SIGNAL STRENGTH** meter. The **TUNING** Meter is not used for AM.

FM: Set the **selector** switch to "FM" and tune to the desired station. Then slowly rotate the **TUNING** knob slightly back and forth until maximum reading is obtained on the **SIGNAL STRENGTH** Meter, and the **TUNING** Meter points to the center scale position.

MUTING SWITCH AND MUTING LEVEL CONTROL

When tuning to FM broadcasts with the **MUTING** switch in its "in" position, the muting circuit will eliminate interstation noise. The muting threshold can be varied by rotating the **MUTING LEVEL** control on the rear panel. To prevent muting very weak stations along with the noise, the muting function may be turned off by releasing the **MUTING** pushswitch to "out" position, and thus switching all muting out of the FM circuits.

FM MONO SWITCH

Depressing the **FM MONO** switch will convert FM output Signal only to the monophonic mode, including signal at the **TAPE OUT**.

VOLUME

This control regulates volume of all four channels simultaneously.

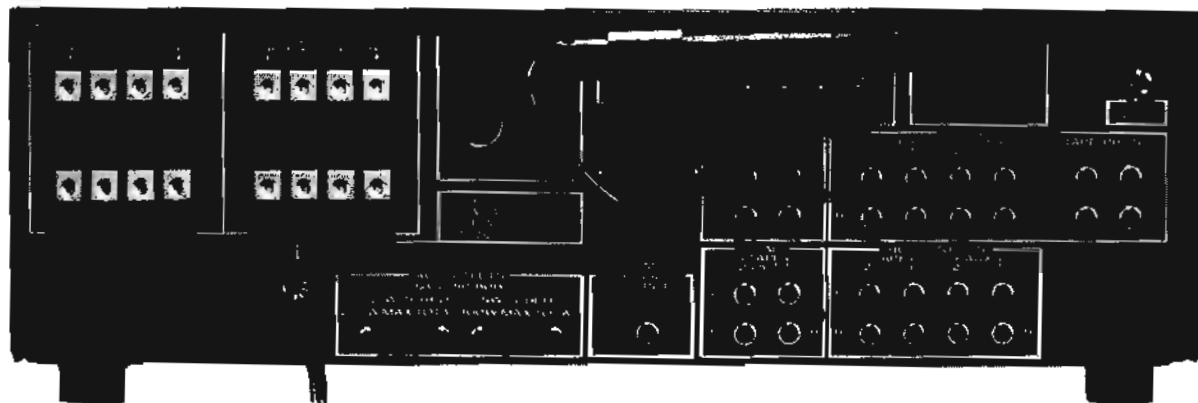

Figure 8. Rear Panel Connection Facilities

REAR PANEL FEATURES

PHONO JACKS

These two jacks are intended for use with magnetic cartridges requiring a standard 47,000-ohm resistive load. If a hum is heard when playing a record, try reversing the polarity of the turntable power plug. If this is ineffective, connect a separate ground wire from the turntable or record changer frame to the **CHASSIS GROUND** binding post of the 4430.

(Refer to "CONNECTING THE 4430", page 2.)

AUX₁ AUX₂ JACKS

These jacks are for connection of any 4-channel high level equipment source. Manufacturers may use different terminology for the four channels, and care should be exercised to avoid confusing the signal channel terminations. The followings are examples of 4-channel nomenclature equivalents:

- LEFT FRONT -LF - LF - CHANNEL 1 -TRACK 1
- LEFT REAR -LR - LB - CHANNEL 2 -TRACK 2
- RIGHT FRONT -RF - RF - CHANNEL 3 -TRACK 3
- RIGHT REAR -RR - RB - CHANNEL 4 -TRACK 4

TAPE IN AND TAPE OUT JACKS

These jacks are for the connection of a 2-channel or 4-channel tape recorder.

(Refer to "SOURCE DEVICES", page 3.)

FM ANTENNA TERMINALS

These terminals connect to an FM antenna. For best FM reception, Marantz recommends a log-periodic antenna mounted on a good quality rotor system. For rural areas, it is recommended that a local dealer be consulted about antenna installation and lightning atrestor protection. Master antenna system is not recommended for use with

your Model 4430; such systems are usually designed expressly for television reception and frequently suppress FM signals before distribution. In addition, master antenna systems often severely limit good quality FM reception. Where outdoor antennas are prohibited or inconvenient, use a simple form of 300 ohm TV "rabbit ear" antenna or the simple ribbon-type folded dipole antenna supplied with the 4430. Both are practical and will give satisfactory results in primary signal areas.

Your Model 4430 will accept either a 75 ohm or 300 ohm antenna. (See diagram Figure 9.) The 300 ohm antenna cable should be connected to the two terminals marked FM on the **ANTENNA** terminal. When using 75 ohm coaxial antenna cable, connect its shield to the **CHASSIS GROUND** terminal, and its inner or center conductor to either of the FM terminals.

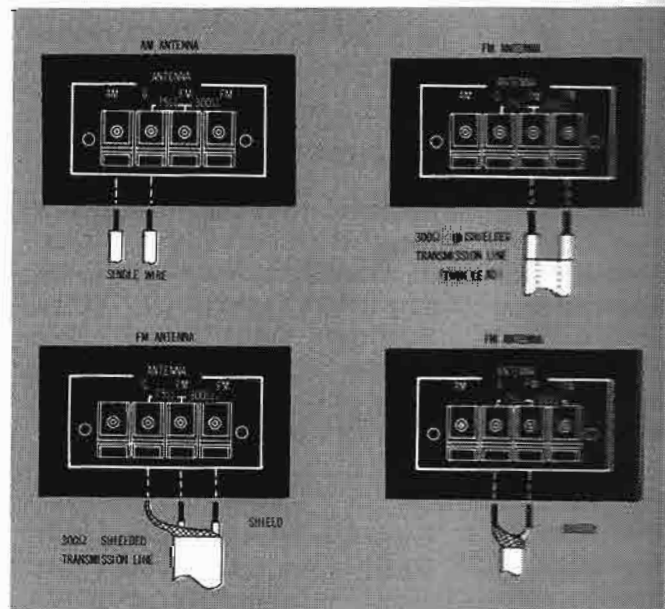

Figure 9. FM/AM Antenna Connection

ANTENNA ATTENUATOR

The **ANTENNA ATTENUATOR** can be switched into or out of the antenna circuit. Use the **ANTENNA ATTENUATOR** switch in the "IN" position only when overloading is apparent from reception of one station at several points of the dial and is affecting reception of a desired station. Overloading may also cause severe distortion which will not disappear with proper antenna orientation.

AM ANTENNA TERMINAL

This terminal connect to an AM antenna. The 4430 is equipped with an ferrite-rod antenna for AM reception and it will give satisfactory results to primary signal areas. However, an outdoor antenna will provide better reception. Two single wires are required to make an AM outdoor antenna. First, connect one end of a single wire to the **AM** antenna terminal on the rear panel, and the other end at a very high position outdoors, or swing it from the window of your room. Next, connect the other single wire between the "G" terminal and an earth ground (such as a water pipe). (Refer Figure 9, page 9 .)

FM QUADRADIAL OUTPUT JACK

In anticipation of the coming of 4-channel stereo broadcast, your model 4430 is equipped with the **FM QUADRADIAL OUTPUT** jack. The signal available at this jack is unequalized output of the FM discriminator. It's frequency response characteristics and signal level are ideal to drive any 4-channel adaptor. This jack can also be used as a simple white noise generator for frequency response check of loudspeakers or amplifiers. For this application, use muting off the model 4430 in FM mode and tune off from any FM signal.

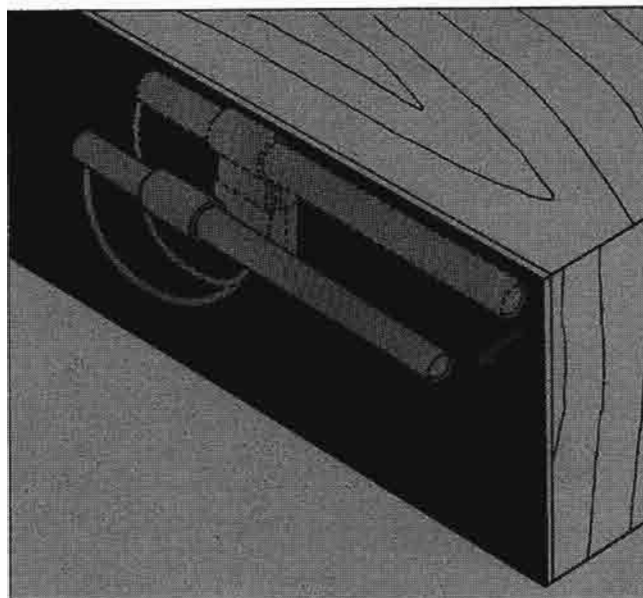

Figure 10. AM Ferrite-rod Antenna

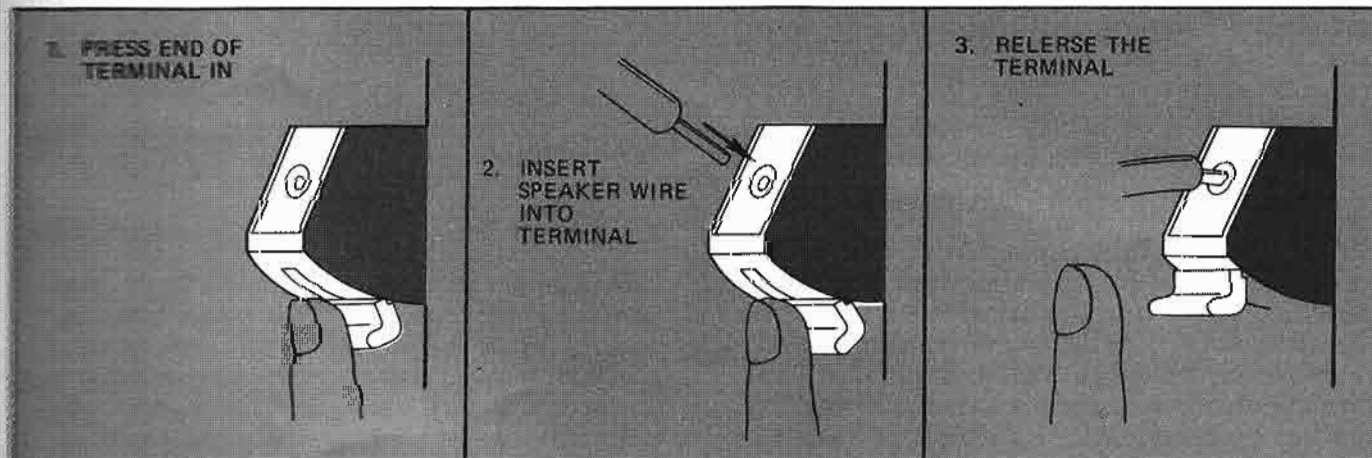

Figure 11. Quick Connect Speaker Terminal

MAIN AND REMOTE SPEAKERS

Sixteen quick-connect terminals are provided; eight for main speakers and eight for remote speakers. (Refer to "CONNECTING THE 4430," page 2 , "REMOTE SPEAKERS," page 3 .)

Terminals work as shown in **Figure 11**.

- 1) Press terminal in
- 2) Insert speaker wire
- 3) Release terminal

CONNECTION TO AC OUTLET

With the front panel power pushswitch "out," plug the line cord into an electrical outlet supplying the proper voltage, **CAUTION: DO NOT PLUG YOUR MODEL 4430 INTO A DC OUTLET. SINCE SERIOUS DAMAGE WILL OCCUR.**

AC CONVENIENCE OUTLETS

Two A.C. outlets, one switched and one unswitched, are provided on the rear panel to supply power to associated components of the system (tape recorder, record player, etc.) The maximum power available from the **UNSWITCHED** and **SWITCHED A.C. OUTLETS** is 200 Watts and 100 Watts, respectively.

REMOTE CONTROL

This rear panel **REMOTE CONTROL** connector and front-panel switch are intended for use only with the optional Model RC-4 Remote Control. For use, follow the instructions supplied with the RC-4.

EXTERNAL DECODER CONNECTION

A pocket on the bottom of the chassis will accommodate Marantz 4-channel decoders such as the Model SQA-1. For use, follow the instructions supplied with the optional decoder.

TAPE RECORDING

Instructions for connecting a recorder and playing back a tape are given in "SOURCE DEVICES," page 3 .

To record, select the desired program source, using the selector switch. Put the recorder connected to the **TAPE OUT** jacks "1 or 2" in the record mode.

For additional information, refer to "mode SWITCH," page 4 , and **TAPE/SOURCE MON SWITCH**," page 6 .

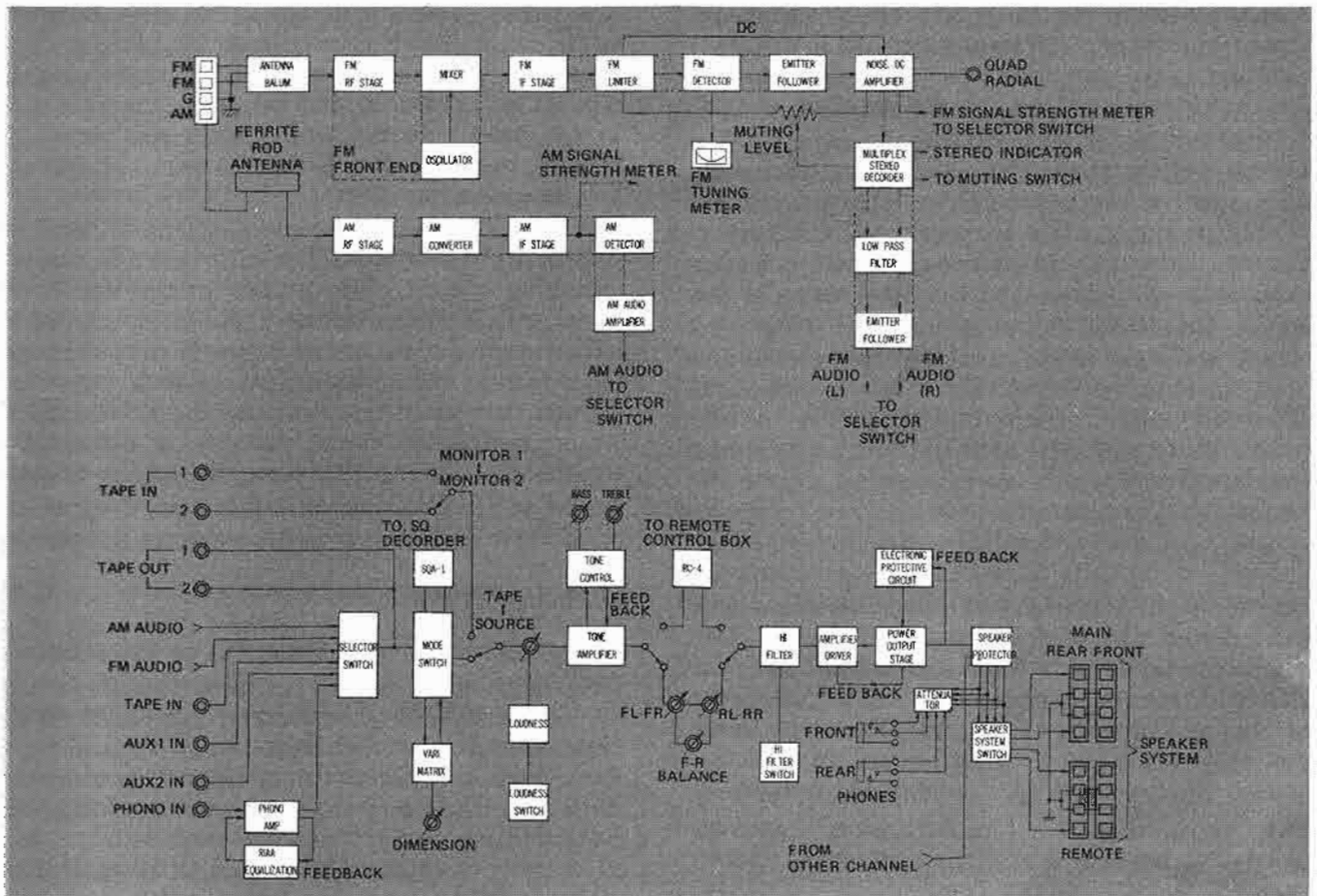

Figure 12. Functional Block Diagram

TECHNICAL DESCRIPTION

GENERAL

Figure 12 is a block diagram of the model 4430 Quadradial 4 Receiver showing main functional elements and input and output signal routing. For clarity, only a single audio channel is shown; other channels are identical. PHONO and Tape input jacks are provided only for the front pair of channels.

FUNCTIONAL DESCRIPTION

FRONT END

FM antenna signals are applied through a balun transformer and the ANTENNA ATTENUATOR switch to the antenna coil which drives a field-effect transistor RF amplifier. When the ANTENNA ATTENUATOR slideswitch is placed in the "out" position the attenuator circuit is cut off and the FM signals are directly fed to the FM antenna coil. With antenna ATTENUATOR slide-

switch placed in the "in" position, the signals are attenuated about 20dB by the attenuator network, then fed to the antenna coil. The signals from the RF amplifier are fed through the double-tuned RF tank circuit to the FET Mixer stage, which is also fed by the signal generated by a local oscillator. This mixer converts the carrier frequency to the 10.7 MHz intermediate frequency. Careful attention to its thermal and electrical characteristics has minimized drift, thus obviating the necessity for AFC. The 10.7 MHz converted signal is then fed to a phase-linear ceramic IF filter, followed by the limiter. It is then, in turn, processed through an FM discriminator. The output of the FM discriminator is fed to a buffer amplifier which then drives the demodulator.

IF STAGES

The IF section consists of six transistors and three pieces of dual elements ceramic filters. The characteristics of this filter are ideal in that the 200KHz passband is phase-linear, with sharp cut-off slopes. Its exceptional phase linearity assures the elimination of a major source of high-frequency distortion and a loss of stereo separation. The sharp cut-off slopes provide improved selectivity, permitting reception of closely spaced channels.

LIMITER

The Model 4430 utilizes multi-stages (transistor plus limiter diode) limiter amplifier with a very small dynamic symmetrical aperture, eliminating the need for AGC circuit which introduces low frequency distortion. Undesirable Amplitude Modulation (AM signals, AM noise, AM distortion) are removed from the IF signal within the limiter.

FM STEREO DEMODULATOR

The composite audio signal from the buffer amplifier is fed into the multiplex stereo demodulator circuit consisting of 11 transistors and 6 diodes. The 19KHz pilot signal contained in the composite audio signal is doubled into 38KHz after two-stage amplification and then the 38KHz signal is further amplified to the level necessary to drive the diode switching circuit. The composite audio signal is split into the right and left channels by the 38KHz switching signal in the diode matrix circuit. The right and left channel audio signals are processed in the crosstalk cancelling circuit which utilizes complementary configuration with NPN and PNP transistors. The audio signals are then fed into the low pass filters for filtering undesired 19-and 38KHz components and emitter followers for low impedance output.

The stereo demodulator circuit has been designed with the de-emphasis network to provide flat frequency response up to 15KHz. One hundred percent air-tight coils and filters are incorporated in the stereo demodulator circuit for improved stability and reliability with good stereo separation and frequency response.

The multiplex stereo demodulator circuit has been provided with an automatic stereo/monaural switching circuit. The circuit checks the input signal intensity and activates the stereo demodulator circuit and the stereo indicator lamp automatically only when the input signal is powerful enough to provide good quality stereo reception. When the input signal strength is below the threshold level, the FM stereo broadcast is processed as monaural signal and improved signal-to-noise ratio is obtained in this mode of operation.

MUTING CIRCUIT

In the absence of an FM carrier, all FM receivers produce a peculiar noise. The muting circuit eliminates this noise, providing you with noise-free tuning from station-to-station.

A muting circuit, consisting of a two-transistor noise amplifier and a three-transistor (including one FET) switching circuit, has been incorporated in the Model 4430. The muting circuit perfectly mutes out all the interstation noise and also completely mutes out the side slope spurious response of the unit. The circuit has been designed to minimize annoying "pop" noise for velvet smooth tune in and tune out.

AM TUNER

The AM tuner portion of the Model 4430 has been provided with a tuned RF amplifier incorporating a three-section variable capacitor for improved spurious response ratio.

The ceramic filter utilized in the AM IF amplifier comes with higher selectivity and wider bandwidth for interference-free hi-fi AM reception.

Following the AM IF amplifier, the AM detector recovers the audio modulation and provides this signal to the mode selection switch.

The AM tuner and IF amplifier are subjected to the action of an effective automatic gain control circuit which maintains constant the level of all stations in the AM band.

PHONO AMPLIFIERS

These amplifiers permit phono signals of up to 100 millivolts to be handled without overloading. The RIAA equalization network provides precise equalization and sets the phono preamplifier voltage gain to 40dB (at 1,000Hz). Figure 15 shows the

RIAA reproducing characteristic together with the recording characteristic. The net result after playback is a flat frequency response.

SELECTOR SWITCH

The selector switch selects the program source for listening or recording. The Model 4430 has four sets of input jacks: PHONO, TAPE, AUX₁ and AUX₂. Any discrete 4-channel program source can be connected to the AUX₁ and AUX₂ jacks. The input sensitivity for each set of input jacks is 1.8 millivolts at PHONO, and 180 millivolts at TAPE, AUX₁ and AUX₂. The selector switch outputs are fed through the TAPE OUT jacks on the rear panel to the mode switch.

MONITOR (TAPE/SOURCE) SWITCH

When the MONITOR (TAPE/SOURCE) pushswitch is in the "out" position tape input signals from the TAPE (1 or 2) jacks on the rear panel are fed to the mode switch. When the MONITOR (TAPE/SOURCE) is depressed, the output of the mode switch is disconnected from the balance control and the tape input signals from the TAPE IN jacks feed the balance control directly.

MONITOR (1 or 2) SWITCH

This switch selects between the tape TAPE 1 or 2 jacks on the rear panel. Depressing the switch selects input signal connected to the TAPE IN 1 jacks and releasing the switch (out position) TAPE IN 2 jacks.

tone CONTROL

After volume level control, each channel program source is fed into the tone control network. The network uses two-stage direct-coupled NPN and PNP configuration at the input stage for the high-impedance termination of the volume control output and low driving impedance to the R-C feed back type tone control network. Each signal adjusted for bass and treble in the tone control network is amplified in two-stage direct-coupled NPN and PNP configuration and is delivered to the balance control/remote control section. The driving impedance to the balance control/remote control section is satisfactorily reduced to NFB. Figure 16 shows the frequency response curves for maximum boost and cut for each control and the curves for 10dB boost and cut at 100Hz and 10KHz.

POWER AMPLIFIER

Four power amplifiers are incorporated for driving left-front, left-rear, right-front and right-rear

speakers. Each of these amplifiers includes pre-amplifier, driver, electronic protective, and output circuits. These amplifiers consist of four totally direct coupled and differential amplifiers to provide superior dynamic characteristics, the frequency response and satisfactory D.C. stability. The output stage employs eight high current, high voltage, triple-diffused silicon output transistors having superior linearity and sufficient collector loss margin arranged in a quasi-complimentary Darlington format. Figure (17) shows the distortion factor-to-output characteristics of the Model 4430: Figure (18) is the frequency response. This stage incorporates a pair of push-pull, complementary-symmetry transistors (PNP, NPN). The electronic protective circuit comprised of two transistors and four diodes for each channel, senses the peak output current and limits the current to the driver transistors at a safe, predetermined value. This limiting current protects the driver and output transistors under overdrive and short circuit conditions and effectively prevents the driver and output transistor from exceeding safe operating conditions.

TECHNICAL SPECIFICATIONS

FM SECTION:

| | |
|---|------------------------|
| Tuning Frequency Range | 88 – 108MHz |
| IHF M Usable Sensitivity | 2.3 μ V |
| IHF Selectivity | 60dB |
| Capture Ratio | 1.6dB |
| Image Rejection Ratio at 106MHz | 70dB |
| Signal to Noise Ratio (Mono) | 70dB |
| Signal to Noise Ratio (Stereo) | 60dB |
| Total Harmonic Distortion (Mono) | 0.15% |
| Total Harmonic Distortion (Stereo) | 0.3% |
| Frequency Response (ref. 75 μ sec. de-emphasis) | 50Hz – 15KHz \pm 1dB |
| Stereo Separation at 1KHz | 42dB |
| Quadradial Output (400Hz 75KHz dev.) | 300mV |

AM SECTION:

| | |
|----------------------------------|---------------|
| Tuning Frequency Range | 540 – 1605KHz |
| Usable Sensitivity | 20 μ V |
| Selectivity | 26dB |
| Image Rejection Ratio at 1400KHz | 70dB |
| Signal to Noise Ratio | 43dB |
| Frequency Response (-3dB) | 50Hz – 4KHz |
| Total Harmonic Distortion | 1% |

AUDIO SECTION:

| | |
|---|---|
| Input Impedance – Low level input | Phono 47 Kohm |
| – High level input | 100 Kohm |
| Input Sensitivity – Phono | 1.8mV for 30W output |
| – High level | 180mV for 30W output |
| Frequency Response | 1.0dB, 20Hz to 20KHz at 1W output |
| Intermodulation Distortion | Less than 0.3% at rated power output from 40Hz to 16KHz with all channels driven (S.M.P.T.E.) |
| Total Harmonic Distortion | Less than 0.3% at rated power output 20Hz to 20KHz with all channel driven |
| Damping Factor | Greater than 45 into 8 ohms load |
| Total Noise – From magnetic phono input to power amp output | Less than 2 μ V equivalent input at rated output into 8 ohms load |
| Volume Tracking | Within 4dB |
| Rated Continuous (RMS) Output per channel, all channels operating simultaneously | 30W at 4 ohms 30W at 8 ohms 18W at 16 ohms |
| Comparable Total Music Power | 180W at 8 ohms |

GENERAL:

| | |
|---|--------------------|
| Power Requirements | 120V AC 50 to 60Hz |
| Power Consumption – at rated power output, all channels | 420 watts |
| – idling (no signal) | 30 watts |
| Dimensions – Panel Width | 17 21/64 |
| – Panel Height | 5 25/64 |
| – Depth | 14 3/8 |
| Weight – Unit alone | 38.5 lbs |
| Packed for Shipment | 49.5 lbs |

* These specifications and exterior designs may be changed for improvement without advance notice.

TYPICAL PERFORMANCE CURVE

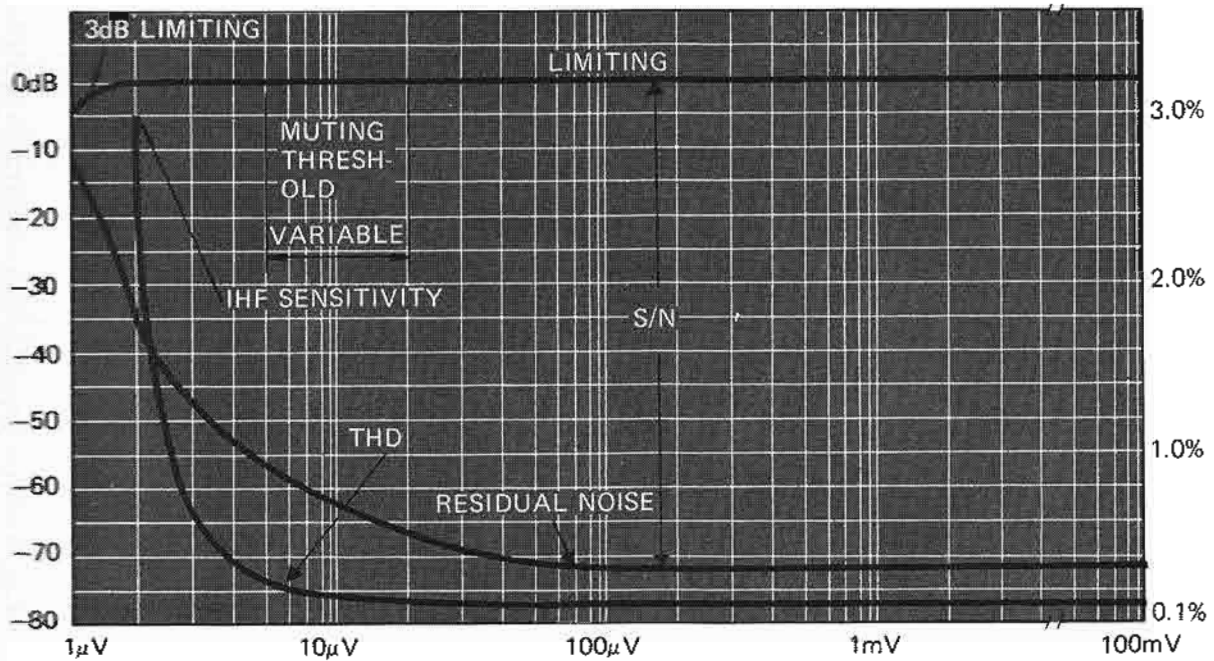

Figure 13. FM Characteristics

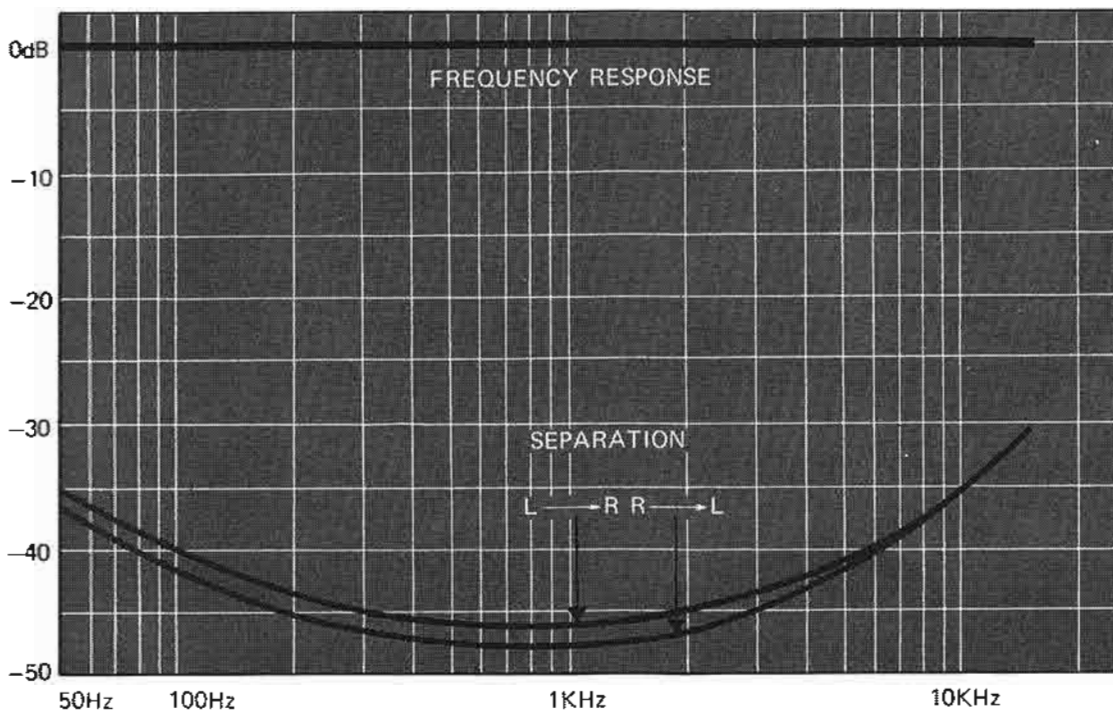

Figure 14. Stereo Separation

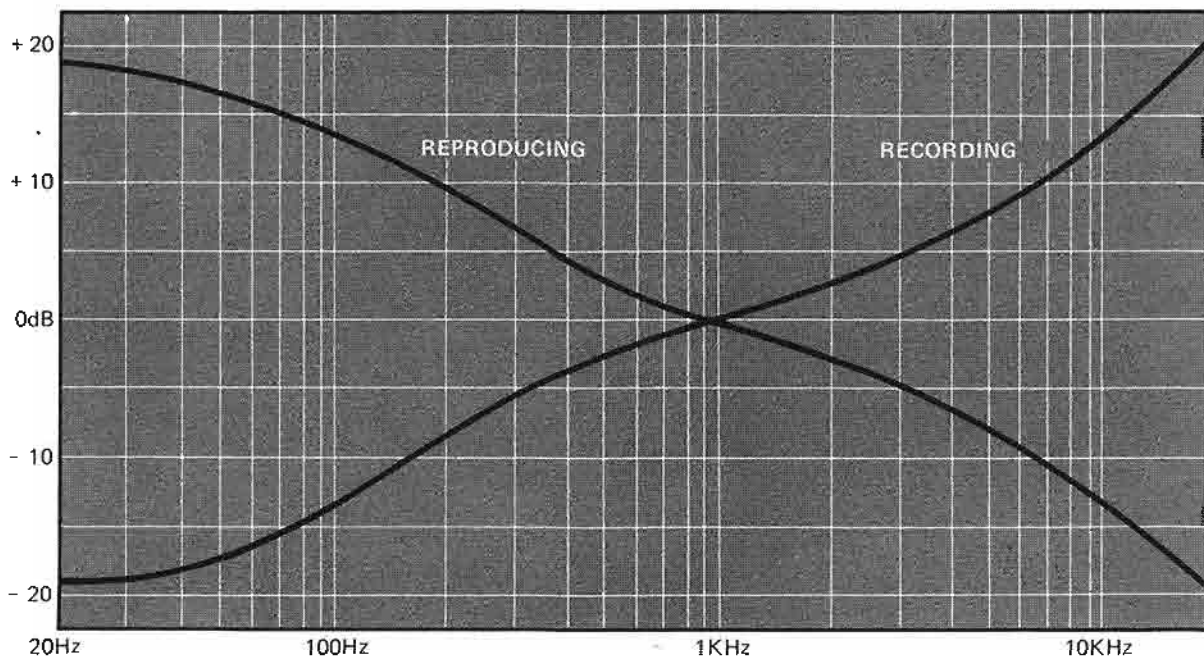

Figure 15. Phono Equalization Characteristics

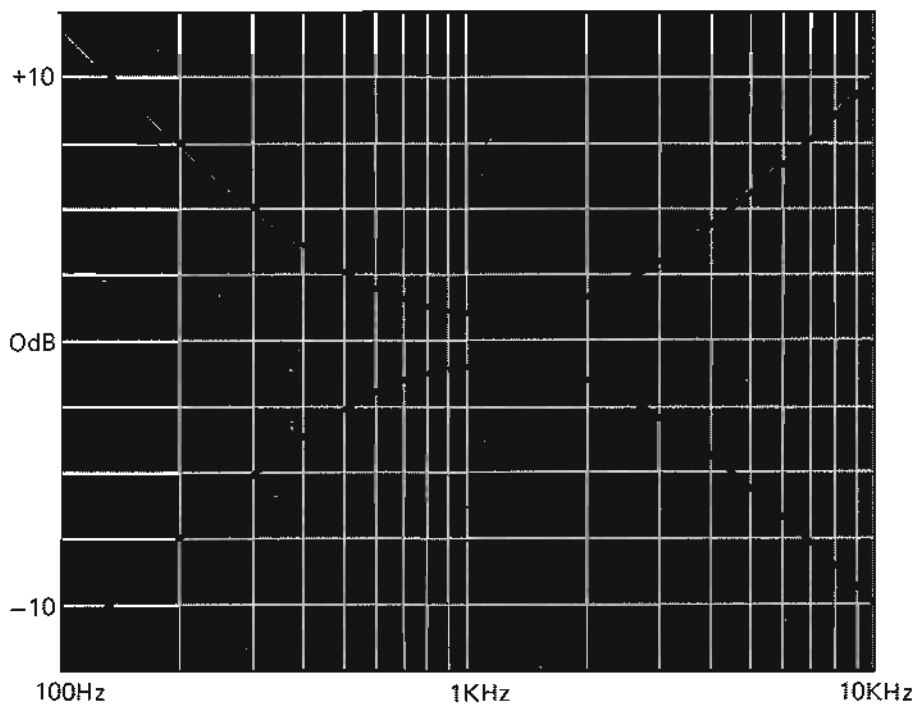

Figure 16. Tone Control Characteristics

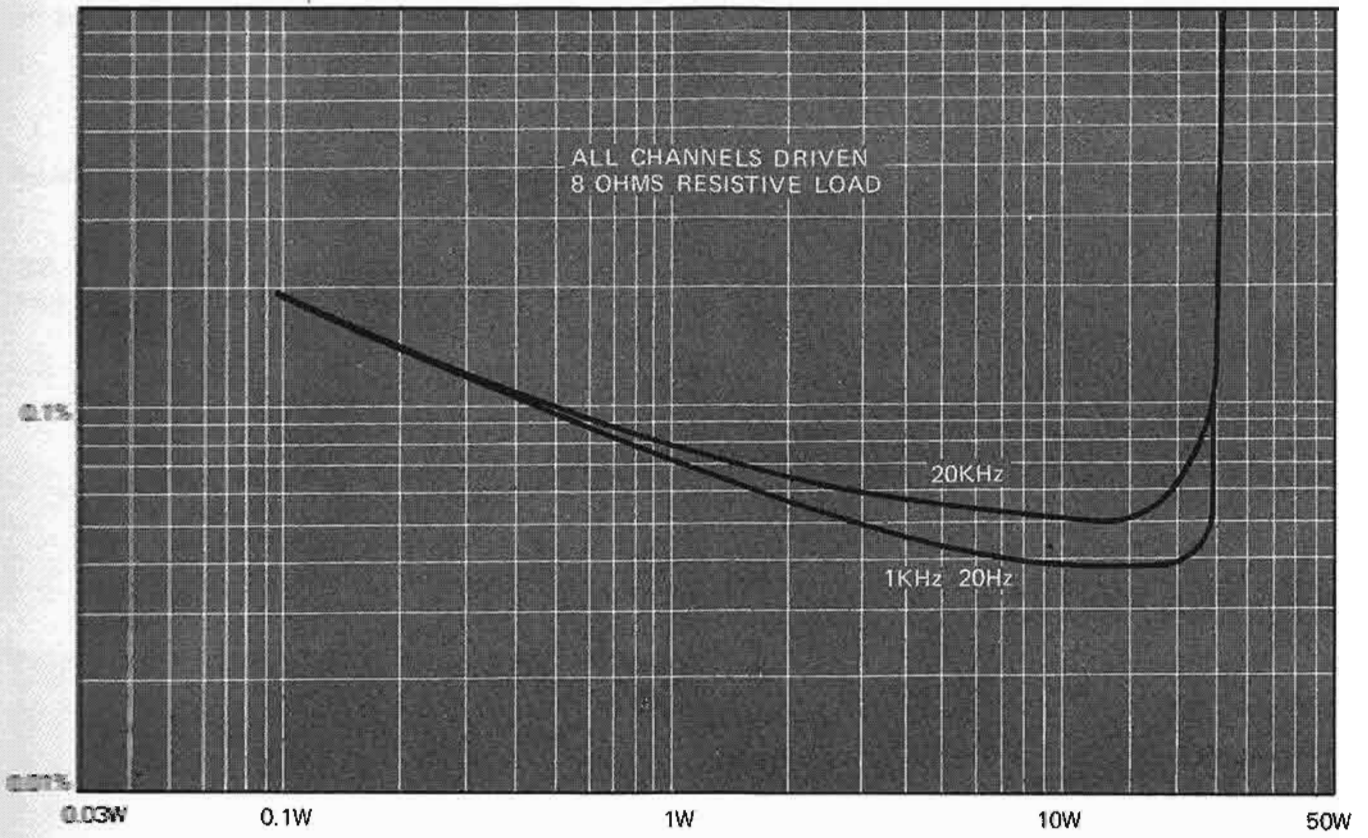

Figure 17. Harmonic Distortion

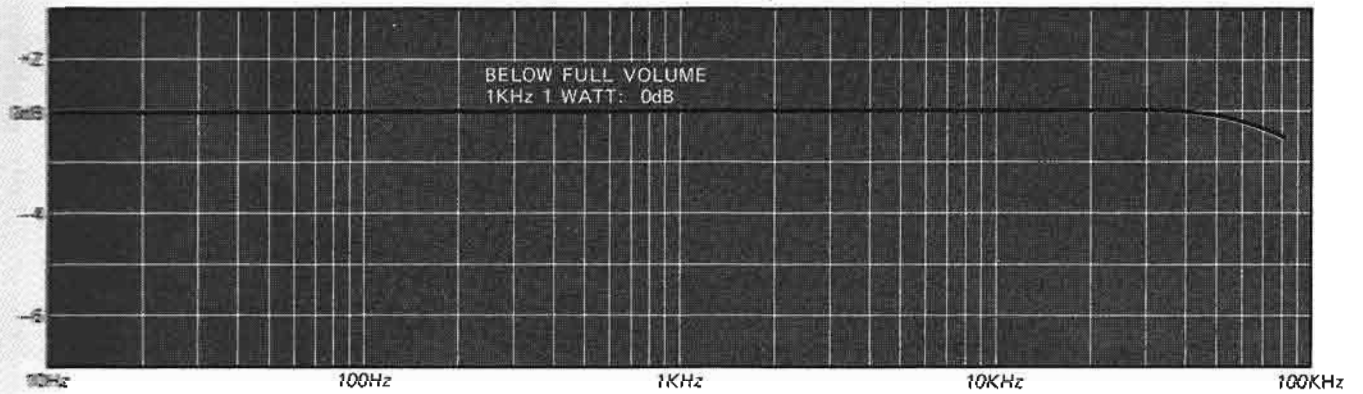

Figure 18. Frequency Response

Please Pack the Receiver as Illustrated.

CAUTION

Please **DO NOT** ship your receiver mounted in its accessory walnut cabinet.

Insure the receiver for full value:

Make sure that your correct return address is on shipping label.

Ship via a reputable carrier (**DO NOT USE PARCEL POST**). Be sure to obtain receipt from carrier.

SERVICE NOTES

REPAIRS

Only the most competent and qualified service technicians should be allowed to service the Marantz Model 4430 Quadradial 4 Receiver. The Marantz Company and its warranty station personnel have the knowledge and special equipment needed for the repair and calibration of this precision instrument.

In the event of difficulty, write directly to the factory (to the attention of the technical service department) for the name and address of the nearest Marantz warranty or authorized service station. Please include the model and serial number of the unit together with a description of the problem.

If it should ever be necessary to ship the unit to the factory or authorized service station and your receiver is mounted in its accessory walnut cabinet, **ALWAYS REMOVE IT FROM THE CABINET BEFORE PACKING. DO NOT SHIP THE ACCESSORY WALNUT CABINET.** Pack the unit carefully, using the original packing material. If the packing material has been discarded, lost, or damaged, write to the factory (to the attention of the technical service department) for new packing material. Carton, fillers, and packing instructions will be shipped to you at a nominal charge.

No receiver should be returned to the factory without an Authorized Return Label which the Marantz Company will supply if the description of difficulties appears to warrant factory service.

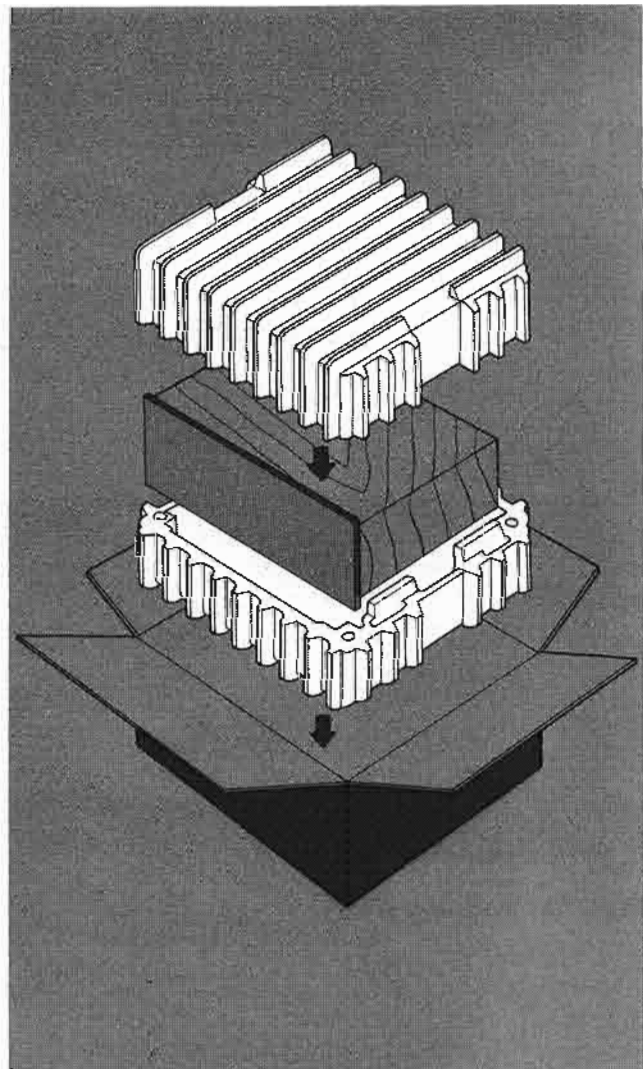

Figure 19. Packing Instructions